

SensoIRIS M140 IS Combined Fire Alarm Detector

EN54-5/ 7/ 17

Description

SensoIRIS M140 IS, is an addressable combined (temperature and optical-smoke) detector with built-in isolator module, designed for installing in addressable fire alarm systems supporting TTE communication protocol. The detector is powered on from the panel and can be controlled via the communication protocol.



Technical and Environmental Specifications

Operating Voltage Range	15 - 32VDC (Nom. 27VDC)
Consumption in quiescent state, no communication	< 190µA@27VDC
Consumption in quiescent state, with communication	< 310µA@27VDC
Consumption in alarm state, with communication	6.5mA
Class (in accordance with EN54-5)	A1R
Sensitivity (in accordance with EN54-7)	High/ Normal/ Middle/ Low
Protected area	up 120m ²
Installation height	up 16m
Output in alarm state at terminal RI (terminals 4/ 1)	7.5 mA (max)/ 7.5V
Wire Gauge for terminals	0.4mm ² - 2.0mm ²
Operating temperature	-10°C to +60°C
Relative humidity resistance	(93 ± 3)% @ 40°C
Protection	IP30
Weight (including base)	~125g
Dimensions (including base)	103x49mm

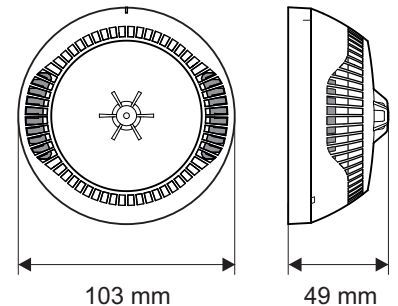

DoP No: 020

1293-CPR-0449
EVPU: N.B.1293

Packing Information

• **Master box** - 10 units SensoIRIS M140 IS, dimensions 396 x 109 x 109 mm, without base. All detectors are protected with a plastic cap.

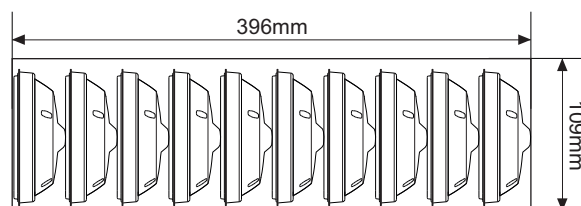

Compatible Product Range

- **IRIS** - Addressable Fire Alarm Panel, 96 zones
- **SIMPO** - Addressable Fire Alarm Panel, 16 zones
- **SensoIRIS FRI-1** - Remote Fire Indicator
- **SensoIRIS B124** - Standard Base
- **Deep Base** - Accessory for mounting on rough surfaces, outdoor pipelines, etc.
- **SensoIRIS Programmer** - Address Programming Tool

Contact Information